

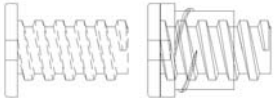



## ACCESSORI TIERRE 590TH "VARI"

| sigla   | profilo   | descrizione                              |
|---------|---|--|
| Ra 1033 |    | CAPPETTA DI DRENAGGIO                    |
| Ra 1404 |    | REGOLATORE A MURO                        |
| Ra 1420 |    | CAVALLOTTO PER TR5910                    |
| Ra 1421 |    | CAVALLOTTO PER TR5911                    |
| Ra 1422 |    | ANGOLI PER FERMAVETRI ARROTONDATI        |
| Ra 2601 |   | BOCCOLA SCARICO ACQUA                    |
| Ra 1737 |  | CLIP PER FERMAVETRI                      |
| Ra 2342 |  | RUOTA PER INSERIMENTO GUARNIZIONE Rg 406 |
| Ra 3822 |  | ESPANSO SOTTOVETRO 25X6 mm               |



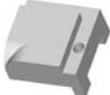
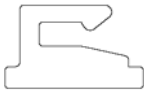

## ACCESSORI TIERRE 590TH "SQUADRETTE"

| sigla   | profilo   | descrizione  |
|---------|---|--|
| Ra 1048 |  | SQUADRETTA A TIRAGGIO MECCANICO PER IMBOTTI CAPANNONI          |
| Ra 1410 |  | SQUADRETTA DI ALLINEAMENTO PER TR5930, TR5931, TR5939 E TR5941 |
| Ra 1411 |  | SQUADRETTA DI ALLINEAMENTO PER IMBOTTI CAPANNONI               |
| Ra 1704 |  | SQUADRETTA DI ALLINEAMENTO PER ANTE V.I.                       |
| Ra 3804 |  | SQUADRETTA DI ALLINEAMENTO A TIRAGGIO                          |

## ACCESSORI TIERRE 590TH "SQUADRETTE"

| sigla   | profilo   | descrizione  |
|---------|---|--|
| Ra 1711 |    | SQUADRETTA A CIANFRINARE CASSA INTERNA   |
| Ra 3813 |    | SQUADRETTA A TIRAGGIO MECCANICO CASSA INTERNA CON BOTTONE DA 8 mm                |
| Ra 3817 |    | SQUADRETTA A TIRAGGIO MECCANICO CASSA INTERNA PER MAGGIORATI CON BOTTONE DA 8 mm |
| Ra 1423 |    | SPINA DA 8 mm  |
| Ra 1705 |    | SQUADRETTA A SPINARE CASSA INTERNA   |
| Ra 1707 |   | SQUADRETTA A SPINARE CASSA INTERNA PER MAGGIORATI                                |
| Ra 1714 |  | SQUADRETTA A SPINARE CASSA INTERNA PER TR5932 E TR5941                           |
| Ra 3806 |  | SQUADRETTA A CIANFRINARE CASSA ESTERNA ANTA MAGGIORATA                           |
| Ra 3807 |  | SQUADRETTA A CIANFRINARE CASSA INTERNA PER ANTE TR5943                           |
| Ra 3808 |  | SQUADRETTA A CIANFRINARE CASSA ESTERNA PER ANTA TR5932 E TR5933                  |
| Ra 3809 |  | SQUADRETTA A CIANFRINARE CASSA ESTERNA PER ANTA TR5938 E TR5941                  |
| Ra 3805 |  | SQUADRETTA A CIANFRINARE   |
| Ra 3819 |  | SQUADRETTA A AVVITARE CASSA ESTERNA TR5905                                       |
| Ra 3826 |  | SQUADRETTA A SPINARE, CIANFRINARE E CON GRANO CASSA ESTERNA ANTA                 |

## ACCESSORI TIERRE 590TH "CERNIERE"

| sigla   | profilo  | descrizione   |
|---------|--|---|
| Ra 1427 |   | CERNIERA FLASH BASE                                       |
| Ra 1428 |   | CERNIERA FLASH BASE<br>PER SOLUZIONE COMPLANARE O 3ª ANTA |
| Ra 1430 |   | CERNIERA PER PORTE FLASH XL                               |
| Ra 1431 |   | CERNIERE PER PORTE FLASH<br>XL SOL. COMPLANARE O 3ª ANTA  |
| Ra 1440 |  | CERNIERA PER VASISTAS                                     |







## ACCESSORI TIERRE 590TH "CREMONESI"

| sigla   | profilo   | descrizione   |
|---------|---|---|
| Ra 1031 |  | CREMONESE UNICA SENZA ARTICOLI CORRELATI                        |
| Ra 1056 |  | CREMONESE PRIMA   |
| Ra 1057 |  | CREMONESE PRIMA 900 PER ANTA RIBALTA                            |
| Ra 1447 |  | BLOCCHETTI DI COLLEGAMENTO                                      |
| Ra 1454 |  | CURSORI E VITI IN ABBINAMENTO A Ra 1031<br>PER APERTURA INTERNA |
| Ra 1429 |  | CRICCHETTO CICO   |



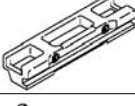
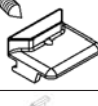









## ACCESSORI TIERRE 590TH "TAPPI"

| sigla   | profilo   | descrizione   |
|---------|---|---|
| Ra 3820 |  | TAPPO RISCONTRO CENTRALE GIUNTO APERTO                          |
| Ra 3823 |  | TAPPO RISCONTRO CENTRALE DOPPIA BATTUTA                         |
| Ra 3821 |  | TAPPO RISCONTRO CENTRALE<br>PER SISTEMA CON FERRAMENTA A NASTRO |
| Ra 3830 |  | TAPPO RISCONTRO CENTRALE PIANO PER GIUNTO APERTO                |
| Ra 3831 |  | TAPPO RISCONTRO CENTRALE PIANO<br>PER FERRAMENTA A NASTRO       |







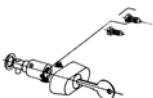

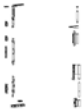

## ACCESSORI TIERRE 590TH "ACCESSORI DI CHIUSURA"

| sigla   | profilo   | descrizione                         |
|---------|---|-------------------------------------|
| Ra 1002 |  | TERMINALE PER ASTE                  |
| Ra 1035 |  | CATENACCIO GIAP                     |
| Ra 2905 |  | INCONTRO ASTE E TERZA CHIUSURA      |
| Ra 2906 |  | INCONTRO SINGOLO O DOPPIO           |
| Ra 2907 |  | INCONTRO PER art. Ra 2918           |
| Ra 2908 |  | INCONTRO DOPPIO                     |
| Ra 2909 |  | ROSTRO DI CHIUSURA REGISTRABILE     |
| Ra 2910 |  | BRACCIO LIMITATORE DI APERTURA FRIZ |
| Ra 2911 |  | BRACCIO LUNGO RALLENTY mm 250       |

## ACCESSORI TIERRE 590TH "ACCESSORI DI CHIUSURA"

| sigla   | profilo   | descrizione                          |
|---------|---|--------------------------------------|
| Ra 2912 |    | BRACCIO CORTO RALLENTY mm 150        |
| Ra 2913 |    | CATENACCIO REGISTRABILE              |
| Ra 2914 |    | TAPPO SOSTENIMENTO ANTE              |
| Ra 2915 |    | MARTELLINA MASTERMAR                 |
| Ra 2918 |   | NOTTOLINO DI CHIUSURA                |
| Ra 1433 |  | MOVIMENTAZIONE INTERNA BIDIREZIONALE |
| Ra 1436 |  | INCONTRO PER DOPPIA E TERZA CHIUSURA |
| Ra 1437 |  | INCONTRO SINGOLO                     |
| Ra 1441 |  | TERMINALE REGISTRABILE               |
| Ra 1442 |  | CATENACCIO TOTEM                     |
| Ra 1444 |  | COMANDO BIDIREZIONALE A LEVA         |
| Ra 1445 |  | FERMA ANTA                           |
| Ra 1452 |  | ASTINA DI COLLEGAMENTO 15/20         |
| Ra 1457 |  | SERRATURA DI BLOCCAGGIO              |

## ACCESSORI TIERRE 590TH "ANTA RIBALTA BASE"

| sigla   | profilo   | descrizione  |
|---------|---|--|
| Ra 1458 |    | MECC. BASE AR FUTURA   |
| Ra 1459 |    | BRACCIO TIPO 1 ANTA RIBALTA FUTURA                           |
| Ra 1460 |    | BRACCIO TIPO 2 ANTA RIBALTA FUTURA                           |
| Ra 1461 |    | CHIUSURA SUPPLEMENTARE FUTURA                                |
| Ra 2921 |   | CATENACCIO REGISTRABILE ANTA ABBINATA                        |
| Ra 2922 |  | CATENACCIO GIAP ANTA ABBINATA                                |
| Ra 2923 |  | BRACCIO SUPPLEMENTARE PER ANTA RIBALTA                       |
| Ra 1456 |  | CATENACCIO ANTA ABBINATA                                     |
| Ra 1443 |  | COMANDO BIDIREZIONALE A LEVA<br>NELLA SOLUZIONE ANTA RIBALTA |
| Ra 1435 |  | MOVIMENTAZIONE INTERNA MONODIREZIONALE                       |
| Ra 1462 |  | CERNIERA ANTA ABBINATA                                       |



## ACCESSORI TIERRE 590TH "ANTA RIBALTA COMPLANARE"

| sigla   | profilo   | descrizione   |
|---------|---|---|
| Ra 1455 |  | MECCANISMO ANTA RIBALTA<br>PER SOLUZIONE COMPLANARE |

## ACCESSORI TIERRE 590TH "ANTA RIBALTA COMPLANARE"

| sigla   | profilo  | descrizione  |
|---------|--|--|
| Ra 1025 |   | CATENACCI ANTA ABBINATA A Ra 1455                    |
| Ra 1044 |   | BRACCIO TIPO 1<br>ANTA RIBALTA APPLICABILE A Ra 1455 |
| Ra 1045 |   | BRACCIO TIPO 2<br>ANTA RIBALTA APPLICABILE A Ra 1455 |
| Ra 2919 |   | CHIUSURE SUPPL. VERTICALI APPLICABILI A Ra 1455      |
| Ra 2920 |  | CHIUSURE SUPPL. ORIZZONTALI<br>APPLICABILI A Ra 1455 |

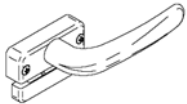
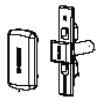
## ACCESSORI TIERRE 590TH "SPORGERE"

| sigla   | profilo   | descrizione  |
|---------|---|--|
| Ra 1729 |  | BRACCIO PER SPORGERE                               |
| Ra 1730 |  | MANIGLIA A TAVELLINO "BRAVO 1"<br>PER GRADINO 8 mm |
| Ra 1731 |  | KIT PER APERTURA ESTERNA MONODIREZIONALE           |
| Ra 1732 |  | TRAINO PER ASTINA                                  |
| Ra 1733 |  | BRACCI LASER INOX                                  |
| Ra 1734 |  | BRACCI LASER ZINCATO                               |

## ACCESSORI TIERRE 590TH "MONOBLOCCO"



| sigla   | profilo  | descrizione                        |
|---------|--|------------------------------------|
| Ra 1036 |   | PASSACINTINO                       |
| Ra 1058 |   | TAPPO RACCOGLI CONDENSA            |
| Ra 1073 |   | TAPPI CASSONETTO MONOBLOCCO        |
| Ra 1419 |   | COPPIA INVITI PER GUIDA TAPPARELLA |
| Ra 1476 |  | KIT MOVIMENTAZIONE MONOBLOCCO      |

## ACCESSORI TIERRE 590TH "SERIE PORTA"

| sigla   | profilo   | descrizione                             |
|---------|---|---|
| Ra 1426 |  | CERNIERA DOMINA 2 ALI int. 55,5 mm      |
| Ra 1432 |  | CERNIERA DOMINA 2 ALI 3D int. 55,5 mm   |
| Ra 1424 |  | CERNIERA DOMINA 2 ALI int. 61 mm        |
| Ra 1425 |  | CERNIERA DOMINA 3 ALI int. 61 mm        |
| Ra 1463 |  | CERNIERA DOMINA HP 2 ALI int. 62,5 mm   |
| Ra 1464 |  | CERNIERA DOMINA HP 3 ALI int. 62,5 mm   |
| Ra 1473 |  | CERNIERA DOMINA 2 ALI INTERASSE 68,5 mm |

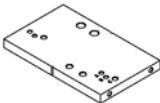
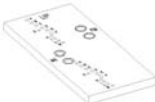
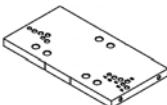
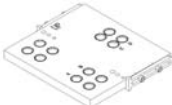
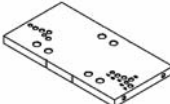
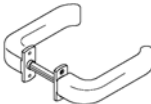
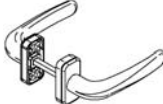

## ACCESSORI TIERRE 590TH "SERIE PORTA"

| sigla   | profilo   | descrizione                             |
|---------|---|---|
| Ra 1474 |    | CERNIERA DOMINA 3 ALI INTERASSE 68,5 mm |
| Ra 1448 |    | DIMA PER CERNIERA Ra1426                |
| Ra 1451 |    | DIMA PER CERNIERA Ra1432                |
| Ra 1449 |    | DIMA PER CERNIERE Ra1424 e Ra1425       |
| Ra 1450 |   | DIMA PER CERNIERE Ra1463 e Ra1464       |
| Ra 1475 |  | DIMA PER CERNIERE Ra 1473 e Ra 1474     |
| Ra 1466 |  | DOPPIA MANIGLIA PER MONTANTE            |
| Ra 1467 |  | DOPPIA MANIGLIA PER FASCIA              |
| Ra 2327 |  | KIT DI TENUTA SOTTOZSOCCOLO 1           |
| Ra 2328 |  | KIT DI TENUTA SOTTOZSOCCOLO 2           |

## ACCESSORI TIERRE 590TH "GRUPPI FRESE E PUNZONATRICI"

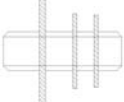









| sigla   | profilo   | descrizione               |
|---------|---|---------------------------|
| Ra 3800 |  | PUNZONATRICE TIERRE       |
| Ra 3816 |  | GRUPPO FRESE TIERRE 590TH |











Guarnizioni

**tierre 590TH**

*Weatherstrips*



|          |         |   |   |
|----------|---------|---|---|
| Scala I: | Rg 402  |    | Guarnizione di battuta interna e a muro<br>Materiale EPDM                             |
|          | Rg 406  |    | Guarnizione centrale di tenuta<br>Materiale EPDM                                      |
|          | Ra 1703 |    | Angolo Vulcanizzato per Rg 406<br>Materiale EPDM                                      |
|          | Rg 331  |    | Guarnizione per riscontro centrale<br>- soluzione a giunto aperto -<br>Materiale EPDM |
|          | Rg 303  |  | Guarnizione per riscontro centrale<br>- soluzione doppia battuta -<br>Materiale EPDM  |
|          | Rg 361  |  | Guarnizione di battuta<br>- soluzione a doppia battuta -<br>Materiale EPDM            |
|          | Rg 407  |  | Guarnizione di isolamento soglia<br>Materiale EPDM                                    |
|          | Rg 329  |  | Guarnizione copricava<br>Materiale EPDM   |
|          | Rg 405  |  | Guarnizione termoacustica<br>Materiale EPDM-EPDM espanso                              |
|          | Rg 358  |  | Spugna per Monoblocco   |
|          | Rg 350  |  | Guarnizione esterna vetro per vano da 2,5 mm<br>Materiale EPDM                        |

|          |        |   |  |
|----------|--------|---|--|
| Scala I: | Rg 351 |    | Guarnizione esterna vetro per vano da 3,5 mm<br>Materiale EPDM                   |
|          | Rg 397 |    | Guarnizione esterna vetro con codina<br>per vano da 2,5÷3,5 mm<br>Materiale EPDM |
|          | Rg 360 |    | Guarnizione esterna vetro per vano da 5 mm<br>Materiale EPDM                     |
|          | Rg 307 |    | Guarnizione interna vetro per vano da 2 mm<br>Materiale EPDM                     |
|          | Rg 320 |  | Guarnizione interna vetro per vano da 3 mm<br>Materiale EPDM                     |
|          | Rg 308 |  | Guarnizione interna vetro per vano da 4 mm<br>Materiale EPDM                     |
|          | Rg 321 |  | Guarnizione interna vetro per vano da 5 mm<br>Materiale EPDM                     |
|          | Rg 309 |  | Guarnizione interna vetro per vano da 6 mm<br>Materiale EPDM                     |
|          | Rg 394 |  | Guarnizione interna vetro con codina<br>per vano da 2÷3 mm<br>Materiale EPDM     |
|          | Rg 395 |  | Guarnizione interna vetro con codina<br>per vano da 3÷4,5 mm<br>Materiale EPDM   |
|          | Rg 396 |  | Guarnizione interna vetro con codina<br>per vano da 4,5÷6 mm<br>Materiale EPDM   |

Scala 1:1

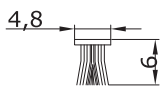
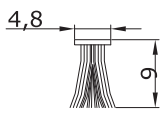
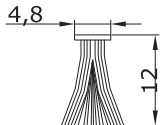
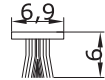
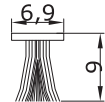
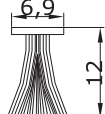
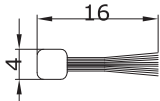
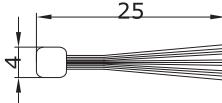
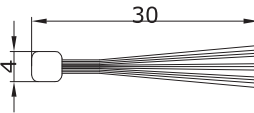
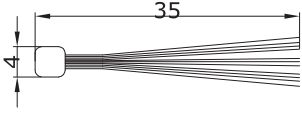
|           |   |   |
|-----------|---|---|
| Rg 333    |    | <p>Profilo Canalina<br/>per sistema con ferramenta a nastro<br/>Materiale PVC</p> |
| 48 x 600  |    | <p>Guarnizione a spazzola 4,8 x 6 mm<br/>Materiale polipropilene</p>              |
| 48 x 900  |    | <p>Guarnizione a spazzola 4,8 x 9 mm<br/>Materiale polipropilene</p>              |
| 48 x 1200 |    | <p>Guarnizione a spazzola 4,8 x 12 mm<br/>Materiale polipropilene</p>             |
| 69 x 600  |   | <p>Guarnizione a spazzola 6,9 x 6 mm<br/>Materiale polipropilene</p>              |
| 69 x 900  |  | <p>Guarnizione a spazzola 6,9 x 9 mm<br/>Materiale polipropilene</p>              |
| 69 x 1200 |  | <p>Guarnizione a spazzola 6,9 x 12 mm<br/>Materiale polipropilene</p>             |
| 40 x 1600 |  | <p>Guarnizione sottozoccolo a spazzola 16 mm<br/>Materiale polipropilene</p>      |
| 40 x 2500 |  | <p>Guarnizione sottozoccolo a spazzola 25 mm<br/>Materiale polipropilene</p>      |
| 40 x 3000 |  | <p>Guarnizione sottozoccolo a spazzola 30 mm<br/>Materiale polipropilene</p>      |
| 40 x 3500 |  | <p>Guarnizione sottozoccolo a spazzola 35 mm<br/>Materiale polipropilene</p>      |